

16

MACHOS Y COJINETES
TAPS AND DIES
TARAUDS ET FILIÈRES
GEWINDEBOHRER UND SCHNEIDEISEN
MASCHI E FILIERE
MACHOS E CAÇONETES
МЕТЧИКИ И ГРЕБЕНКИ



EGA Master ha desarrollado una nueva gama de útiles de roscado (machos y cojinetes) que ofrecen una solución idónea en las tareas de reparación y mantenimiento industrial.

El diseño de estas herramientas se ha realizado con una geometría que asegura la calidad de las roscas obtenidas y mejora la extracción de la viruta. Este diseño cumple, además, con la normativa de referencia.

Los 4 filos de corte y los materiales empleados en la fabricación de los machos y cojinetes (acero rápido: HSS-M2 o HSS-Co) favorecen la duración de la herramienta y minimizan los tiempos de operación necesarios.

La gama de machos y cojinetes de roscar que ha diseñado **EGA Master** incluye todas las roscas de uso común en la industria:

- Rosca métrica, paso normal y fino
- Rosca BSW
- Roscas UNC y UNF
- Rosca GAS (BSP)

EGA Master has developed a new range of threaded tools (taps and dies) that offer a suitable solution at industrial maintenance task and repair actions.

The design of these tools has been made with a geometry that ensures the quality of the threads obtained and improves the extraction of the chip. This design also complies with the reference standards.

The 4 cutting edges and the materials used in the manufacture of the taps and dies (HSS-M2 or HSS-Co steel) improve the tool life and minimize the required operating times.

The range of taps and dies that Ega Master has designed include all the threads commonly used in the industry:

- Metric thread, coarse and fine pitch
- BSW thread
- UNC and UNF threads
- GAS (BSP) thread



EGA Master a développé une nouvelle gamme d'outils de filetage (Tarauds et filières) qui offrent la solution idéale pour les tâches de réparation et de maintenance industrielle.

La conception de ces outils a été réalisée avec une géométrie qui garantit la qualité des filetages obtenus et facilite l'extraction de copeaux. Leur conception est de plus conforme à la norme de référence.

Les 4 arêtes de coupe et les matériaux utilisés dans la fabrication des tarauds et filières (acier rapide: HSS-M2 ou HSS-Co), améliorent la durée de vie de l'outil et réduisent le temps de travail nécessaire.

La gamme de tarauds et filières de filetage conçue par **EGA Master** regroupe tous les types de filetage d'usage régulier dans l'industrie:

- Filetage métrique, pas normal et fin
- Filetage BSW
- Filetage UNC et UNF
- Filetage GAS (BSP)

SET DE 3 MACHOS DE ROSCAR MÉTRICA / METRIC SET OF 3 TAPS / SET DE 3 TARAUDS MÉTRIQUES / SATZ 3 METRISCHE GEWINDEBOHRER / KIT 3 PEZZI MASCHI PER FILETTARE METRICHE / CONJUNTO DE 3 MACHOS DE ROSCAR MÉTRICOS / НАБОР ИЗ ТРЕХ МЕТРИЧЕСКИХ МЕТЧИКОВ

COD.	METRIC	A (mm)	L1 (mm)	L (mm)	g		
57700	2 x 0,4	2,0	8,0	41			
57701	3 x 0,5	2,5	11	48	15		100
57702	4 x 0,7	3,15	13	53	25		
57703	5 x 0,8	4,0	16	58	40		
57704	6 x 1	5,0		66	50		48
57705	7 x 1	4,5	19	66			
57706	8 x 1,25	5,0		72	100		
57707	9 x 1,25	5,6	22	72			
57708	10 x 1,5		24	80	140		20
57709	11 x 1,5	6,3	25	85			
57710	12 x 1,75	7,1	29	89	150		
57711	14 x 2	9,0	30	95			
57712	16 x 2	10	32	102	235		10
57713	18 x 2,5		37	112	470		5
57714	20 x 2,5	11,2		112			
57715	22 x 2,5	12,5	38	118	670		3
57716	24 x 3	14	45	130	835		



ISO 529

ESPECIFICACIONES TÉCNICAS / TECHNICAL SPECIFICATION / DÉTAILS TECHNIQUES

Material / Material / Matière

HSS-M2

CARACTERÍSTICAS / FEATURES / CARACTÉRISTIQUES

Paso normal / Coarse pitch / Pas normal

SET DE 2 MACHOS DE ROSCAR MÉTRICA / METRIC SET OF 2 TAPS / SET DE 2 TARAUDS MÉTRIQUES / SATZ 2 METRISCHE GEWINDEBOHRER / KIT 2 PEZZI MASCHI PER FILETTARE METRICHE / CONJUNTO DE 2 MACHOS DE ROSCAR MÉTRICOS / НАБОР ИЗ ДВУХ МЕТРИЧЕСКИХ МЕТЧИКОВ

COD.	METRIC	A (mm)	L1 (mm)	L (mm)	g		
57725	6 x 0,75	5,0		66	30		90
57726	7 x 0,75	4,5	19	66			
57727	8 x 0,75		22	72	35		63
57728	8 x 1	5,0		72			
57729	9 x 0,75		19	66			
57730	9 x 1	5,6	22	72			
57731	10 x 0,75		20	73	55		42
57732	10 x 1		24				
57733	10 x 1,25						
57734	11 x 0,75	6,3					
57735	11 x 1			80			
57736	11 x 1,25		22				
57737	12 x 0,75				90		30
57738	12 x 1						
57739	12 x 1,25	7,1					
57740	12 x 1,5		29	89			
57741	14 x 1		22	87			
57742	14 x 1,25	9,0	30	95	135		
57743	14 x 1,5		30	95			20
57744	16 x 1	10	22	92	150		
57745	16 x 1,5		32	102			
57746	18 x 1,5				250		
57747	18 x 2	11,2	37	112			10
57748	20 x 1,5				270		
57749	22 x 1,5	12,5	38	118			
57750	24 x 2	14	45	130	400		5



ISO 529

ESPECIFICACIONES TÉCNICAS / TECHNICAL SPECIFICATION / DÉTAILS TECHNIQUES

Material / Material / Matière

HSS-Co

CARACTERÍSTICAS / FEATURES / CARACTÉRISTIQUES

Paso fino / Fine pitch / Pas fin

SET DE 3 MACHOS DE ROSCAR BSW / BSW SET OF 3 TAPS / SET DE 3 TARAUDS BSW / BSW SATZ 3 METRISCHE GEWINDEBOHRER / KIT 3 PEZZI MASCHI PER FILETTARE BSW / CONJUNTO DE 3 MACHOS DE ROSCAR BSW / НАБОР МЕТЧИКОВ СТАНДАРТА BSW (3 ШТ)

COD.	WITWORTH	A (mm)	L1 (mm)	L (mm)	g		
57760	1/8" x 40	2,7	12	40	15	100	
57761	5/32" x 32	3,4	14	45			
57762	3/16" x 24	4,3			35		
57763	1/4" x 20	4,9	22	56	45	48	
57764	5/16" x 18				50		
57765	3/8" x 16	5,5	25	70	75		
57766	7/16" x 14	6,2	30	75	120		
57767	1/2" x 12	7	30	75	135	20	
57768	9/16" x 12				190		
57769	5/8" x 11	9	32	80	220	10	
57770	3/4" x 10	11	40	95	500	5	
57771	7/8" x 9	14,5	40	100	670		
57772	1" x 8	16	50	110	725	3	

DIN 352

ESPECIFICACIONES TÉCNICAS / TECHNICAL SPECIFICATION / DÉTAILS TECHNIQUES

Material / Material / Matière HSS-M2



SET DE 3 MACHOS DE ROSCAR UNC / UNC SET OF 3 TAPS / SET DE 3 TARAUDS UNC / UNC SATZ 3 METRISCHE GEWINDEBOHRER / KIT 3 PEZZI MASCHI PER FILETTARE UNC / CONJUNTO DE 3 MACHOS DE ROSCAR UNC / НАБОР МЕТЧИКОВ СТАНДАРТА UNC (3 ШТ)

COD.	UNC	A (mm)	L1 (mm)	L (mm)	g		
57780	Nº 2 x 56		11	36			
57781	Nº 3 x 48	2,1					
57782	Nº 4 x 40		12	40	15	100	
57783	Nº 5 x 40	2,7					
57784	Nº 6 x 32	3,0	14	45			
57785	Nº 8 x 32	3,4					
57786	Nº 10 x 24		16	48	35		
57787	Nº 12 x 24		18	50			
57788	1/4" x 20	4,9	22	56	45	48	
57789	5/16" x 18		25	63	50		
57790	3/8" x 16	5,5	28	70	75		
57791	7/16" x 14	6,2	30	75	115		
57792	1/2" x 13	7,0	32	80	135	20	
57793	9/16" x 12				190		
57794	5/8" x 11	9,0	36	90	220	10	
57795	3/4" x 10	11	40	95	500	5	
57796	7/8" x 9	14,5	45	110	335		
57797	1" x 8	16	50	110	360	6	

DIN 352 ANSI B1.1

ESPECIFICACIONES TÉCNICAS / TECHNICAL SPECIFICATION / DÉTAILS TECHNIQUES

Material / Material / Matière HSS-M2



SET DE 3 MACHOS DE ROSCAR UNF / UNF SET OF 3 TAPS / SET DE 3 TARAUDS UNF / UNF SATZ 3 METRISCHE GEWINDEBOHRER / KIT 3 PEZZI MASCHI PER FILETTARE UNF / CONJUNTO DE 3 MACHOS DE ROSCAR UNF / НАБОР МЕТЧИКОВ СТАНДАРТА UNF (3 ШТ)

COD.	UNF	A (mm)	L1 (mm)	L (mm)	g		
57800	Nº 2 x 64			32			
57801	Nº 3 x 56	2,1	10				
57802	Nº 4 x 48			36			
57803	Nº 5 x 44						
57804	Nº 6 x 40	3,0	12	40	30	90	
57805	Nº 8 x 36	3,4					
57806	Nº 10 x 32		14	45			
57807	Nº 12 x 28		16	50			
57808	1/4" x 28	4,9					
57809	5/16" x 24		18	56	35	63	•
57810	3/8" x 24	5,5			55	42	
57811	7/16" x 20	6,2		63			
57812	1/2" x 20	7,0			90	30	
57813	9/16" x 18		20	70	135		
57814	5/8" x 18	9,0			150	20	
57815	3/4" x 16	11		80	250		
57816	7/8" x 14	14,5	22		270	10	
57817	1" x 12	16		90	400	5	

DIN 2181 ANSI B1.1

ESPECIFICACIONES TÉCNICAS / TECHNICAL SPECIFICATION / DÉTAILS TECHNIQUES

Material / Material / Matière

HSS-M2



SET DE 2 MACHOS DE ROSCAR GAS (BSP) / GAS (BSP) SET OF 2 TAPS / SET DE 2 TARAUDS GAS (BSP) / SATZ 2 GEWINDEBOHRER GAS (BSP) / KIT 2 PEZZI MASCHI PER FILETTARE GAS (BSP) / CONJUNTO DE 2 MACHOS DE ROSCAR GAS (BSP) / НАБОР МЕТЧИКОВ СТАНДАРТА BSP (2 ШТ)

COD.	GAS (BSP)	A (mm)	L1 (mm)	L (mm)	g		
57820	1/8" x 28	5,5		60	75		
57821	1/4" x 19		20		95	16	
57822	3/8" x 19	9,0		70	135		
57823	1/2" x 14	12	22	80	265	7	•
57824	3/4" x 14	16		90	475		
57825	1" x 11	20	25	100	835	4	

DIN 5157

ESPECIFICACIONES TÉCNICAS / TECHNICAL SPECIFICATION / DÉTAILS TECHNIQUES

Material / Material / Matière

HSS-M2



MACHOS DE ROSCAR NPT / NPT TAPS / TARAUDS NPT / GEWINDEBOHRER NPT / MASCHI A MANO PER FILETTARE NPT / MACHOS DE ROSCAR NPT / МЕТЧИКИ СТАНДАРТА NPT

COD.	NPT	A (mm)	L1 (mm)	L (mm)	g		
57751	1/8" x 27	8	19	54	25		
57752	1/4" x 18	11	27	62	35		60
57753	3/8" x 18	13		65	65		36
57754	1/2" x 14		35	80	135		15
57755	3/4" x 14	17		83	230		8
57756	1" x 11.1/2"	21	44	95	420		
57757	1.1/4" x 11.1/2"	24		125	750		4
57758	1.1/2" x 11.1/5"	29	33	140	1000		
57759	2" x 11.1/5"	35		160	1100		1

DIN 233

ESPECIFICACIONES TÉCNICAS / TECHNICAL SPECIFICATION / DÉTAILS TECHNIQUES

Material / Material / Matière HSS-M2



COJINETES ROSCA MÉTRICA / ROUND METRIC THREAD DIES / FILIÈRES METRIQUE / SCHNEIDEISEN METRISCH / FILIERE TONDE METRICA / CAÇONETES ROSCA MÉTRICA / ПЛАШКИ РЕЗЬБОНАРЕЗНЫЕ МЕТРИЧЕСКИЕ

COD.	METRIC	A (mm)	O.D. mm	g		
57845	2 x 0,4		16	15		
57846	3 x 0,5	5		20		
57847	4 x 0,7		20			
57848	5 x 0,8			25		
57849	6 x 1	7				105
57850	7 x 1					
57851	8 x 1,25	9	25	30		
57852	9 x 1,25					
57853	10 x 1,5		30	55		
57854	11 x 1,5	11				
57856	12 x 1,75		38	85		
57858	14 x 2	14				
57859	16 x 2					30
57860	18 x 2,5	18	45	180		
57861	20 x 2,5					
57864	22 x 2,5	22	55	220		11
57865	24 x 3					
57866	6 x 0,75	7	20	25		
57867	7 x 0,75					
57868	8 x 0,75					105
57869	8 x 1	9	25	30		
57870	9 x 0,75					
57871	9 x 1					
57872	10 x 0,75					
57873	10 x 1					
57874	10 x 1,25	11	30	55		
57875	11 x 0,75					
57876	11 x 1					
57879	12 x 1					
57880	12 x 1,25					30
57881	12 x 1,5	10	38	75		
57882	14 x 1					
57883	14 x 1,25					
57884	14 x 1,5					
57885	16 x 1					
57886	16 x 1,5					
57887	18 x 1,5	14	45	150		
57889	18 x 2					11
57890	20 x 1,5					

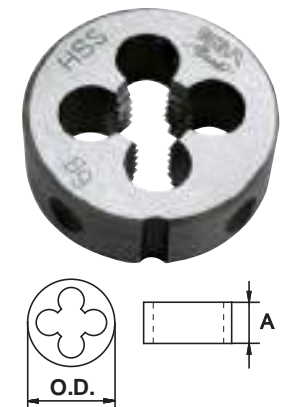

COD.	METRIC	A (mm)	O.D. mm	g		
57891	22 x 1,5					
57892	24 x 1,5	16	55	200	11	•
57893	24 x 2					

DIN 223 EN 22568

ESPECIFICACIONES TÉCNICAS / TECHNICAL SPECIFICATION / DÉTAILS TECHNIQUES

Material / Material / Matière HSS-M2

COJINETES ROSCA BSW / ROUND BSW THREAD DIES / FILIÈRES BSW / SCHNEIDEISEN BSW / FILIERE TONDE BSW / CAÇONETES ROSCA BSW / ПЛАШКИ СТАНДАРТА BSW

COD.	WITHWORTH	A (mm)	O.D. mm	g		
57900	BSW 1/8" x 40	5		20		
57901	BSW 5/32" x 32		20		105	
57902	BSW 3/16" x 24	7		25		
57903	BSW 1/4" x 20					
57904	BSW 5/16" x 18	9	25	30		
57905	BSW 3/8" x 16	11	30	55		
57906	BSW 7/16" x 14				30	•
57907	BSW 1/2" x 12	14	38	85		
57908	BSW 9/16" x 12					
57909	BSW 5/8" x 11	18	45	180		
57910	BSW 3/4" x 10				11	
57911	BSW 7/8" x 9	22	55	220		
57912	BSW 1" x 8					

DIN 223 EN 22568

ESPECIFICACIONES TÉCNICAS / TECHNICAL SPECIFICATION / DÉTAILS TECHNIQUES

Material / Material / Matière HSS-M2

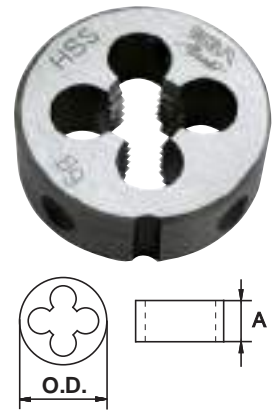

COJINETES ROSCA UNC / ROUND UNC THREAD DIES / FILIÈRES UNC / SCHNEIDEISEN UNC / FILIERE TONDE UNC / CAÇONETES ROSCA UNC / ПЛАШКИ СТАНДАРТА UNC

COD.	UNC	A (mm)	O.D. mm	g		
57920	Nº 2 x 56		16	15		
57921	Nº 3 x 48					
57922	Nº 4 x 40	5				
57923	Nº 5 x 40			20		
57924	Nº 6 x 32				216	
57925	Nº 8 x 32		20			
57926	Nº 10 x 24					
57927	Nº 12 x 24	7		25		
57928	1/4" x 20					
57929	5/16" x 18	9	25	30	105	•
57930	3/8" x 16	11	30	55		
57931	7/16" x 14				30	
57932	1/2" x 13	14	38	85		
57933	9/16" x 12					
57934	5/8" x 11	18	45	180		
57935	3/4" x 10				11	
57936	7/8" x 9	22	55	220		
57937	1" x 8					

DIN 223 EN 22568

ESPECIFICACIONES TÉCNICAS / TECHNICAL SPECIFICATION / DÉTAILS TECHNIQUES

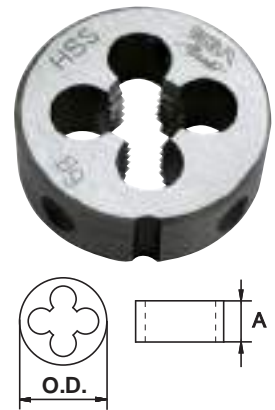
Material / Material / Matière HSS-M2



COJINETES ROSCA UNF / ROUND UNF THREAD DIES / FILIÈRES UNF / SCHNEIDEISEN UNF / FILIERE TONDE UNF / CAÇONETES ROSCA UNF / ПЛАШКИ СТАНДАРТА UNF

COD.	UNF	A (mm)	O.D. mm	g		
57940	Nº 2 x 64	5	16	15		
57941	Nº 3 x 56					
57942	Nº 4 x 48					
57943	Nº 5 x 44					
57944	Nº 6 x 40					
57945	Nº 8 x 36	7	20	20	216	
57946	Nº 10 x 32					
57947	Nº 12 x 28	9	25	30	105	•
57948	1/4" x 28					
57949	5/16" x 24					
57950	3/8" x 24	11	30	55		
57951	7/16" x 20					
57952	1/2" x 20	14	38	85	30	
57953	9/16" x 18					
57954	5/8" x 18					
57955	3/4" x 16	18	45	180	11	
57956	7/8" x 14					
57957	1" x 12	22	55	220		

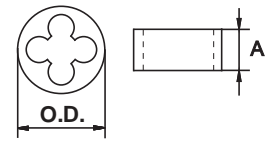

DIN 223 EN 22568

ESPECIFICACIONES TÉCNICAS / TECHNICAL SPECIFICATION / DÉTAILS TECHNIQUES

Material / Material / Matière HSS-M2

COJINETES ROSCA GAS (BSP) / ROUND GAS BSP THREAD DIES / FILIÈRES GAS (BSP) / SCHNEIDEISEN GAS (BSP) / FILIERE TONDE GAS (BSP) / CAÇONETES ROSCA GAS (BSP) / ПЛАШКИ СТАНДАРТА BSP

COD.	GAS (BSP)	A (mm)	O.D. mm	g		
57960	1/8" x 28	11	30	55	30	
57961	1/4" x 19	10	38	75		
57962	3/8" x 19	14	45	150	11	•
57963	1/2" x 14	16	55	200		
57964	3/4" x 14	18	65	275		

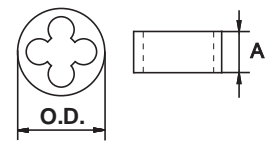

DIN 5158

ESPECIFICACIONES TÉCNICAS / TECHNICAL SPECIFICATION / DÉTAILS TECHNIQUES

Material / Material / Matière HSS-M2

COJINETES ROSCA NPT / ROUND NPT THREAD DIES / FILIÈRES NPT / SCHNEIDEISEN NPT / FILIERE TONDE NPT / CAÇONETES ROSCA NPT / ПЛАШКИ СТАНДАРТА NPT

COD.	NPT	A (mm)	O.D. mm	g		
57897	1/8"	10	38	75	20	
57898	1/4"	15	45	160		
57913	3/8"	20	55	220	8	•
57914	1/2"	22	65	325		
57915	3/4"	25	75	400	4	
57916	1"	26	90	550		
57917	1.1/4"	26	105	650	1	
57918	1.1/2"					
57919	2"					

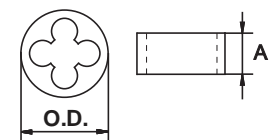

DIN 233

ESPECIFICACIONES TÉCNICAS / TECHNICAL SPECIFICATION / DÉTAILS TECHNIQUES

Material / Material / Matière HSS-M2

GIRAMACHOS DE CARRACA REVERSIBLE / REVERSIBLE TAP WRENCH / PORTE TARAUD RÉVERSIBLE À CLIQUET / KNARRE FÜR GEWINDEBOHRER / GIRAMASCHI CON CRICCO REVERSIBILE / DESANDADOR DE MACHOS COM ROQUETE / РЕВЕРСИВНЫЙ КЛЮЧ ДЛЯ МЕТЧИКОВ

COD.	METRIC	WITHWORTH	GAS (BSP)	L (mm)	g		
57830	M3-M10	1/8"-3/8"	-	85	190	20	
57831	M5-M12	7/32"-1/2"	1/8"	100	290	14	
57832	M3-M10	1/8"-3/8"	-	250	250	10	•
57833	M5-M12	7/32"-1/2"	1/8"	300	445		

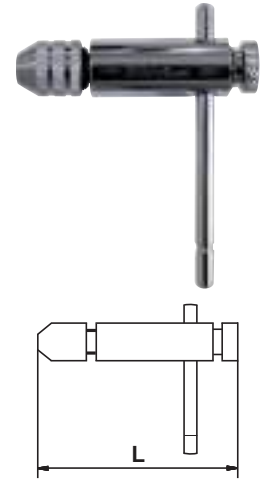

ESPECIFICACIONES TÉCNICAS / TECHNICAL SPECIFICATION / DÉTAILS TECHNIQUES

Material / Material / Matière Acero / Steel / Acier

GIRAMACHOS AJUSTABLE / ADJUSTABLE TAP WRENCH / PORTE TARAUD REGLABLE / VERSTELLBARE WINDEISEN / GIRAMASCHI REGOLABILE / DESANDADOR DE MACHOS AJUSTÁVEL / КЛЮЧ ДЛЯ МЕТЧИКОВ

COD.	METRIC	WITHWORTH	GAS (BSP)	L (mm)	g		
57835	M1-M8	1/16"-5/16"	-	125	55	20	
57836	M3-M10	1/8"-3/8"	-	180	105	12	
57837	M3-M12	1/8"-1/2"	1/8"	200	160	10	
57838	M4-M12	3/16"-5/8"	1/8"-3/8"	280	300		•
57839	M5-M20	1/4"-3/4"	1/8"-1/2"	375	670	6	
57840	M10-M27	1/2"-1"	1/8"-3/4"	500			
57841	M14-M33	5/8"-1.1/4"	1/4"-1"	750	875	4	

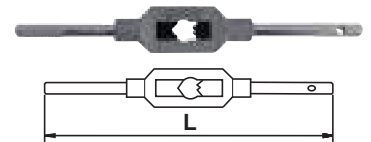

DIN 1814

ESPECIFICACIONES TÉCNICAS / TECHNICAL SPECIFICATION / DÉTAILS TECHNIQUES

Material / Material / Matière Acero + Zamak / Steel + Zamak / Acier + Zamak

PORTACOJINETES / DIE HOLDER / PORTE-FILIÈRE / SCHNEIDEISENHÄLTER / PORTAFILIERE / PORTA CAÇONETES / ПЛАЗКОДЕРЖАТЕЛЬ

COD.	METRIC	WITHWORTH	GAS (BSP)	A (mm)	B (mm)	L (mm)	g		
57970	M1-M2,6	1/16"-3/32"	-	16	5	160	50		
57971	M3-M4	1/8"-5/32"	-	20	7	200	85	20	
57972	M4,5-M6	3/16"-1/4"	-						
57973	M7-M9	5/16"	1/16"	25	9	225	115	12	
57974	M10-M11	3/8"-7/16"	1/8"	30	11	280	220		
57975	MF12-MF14	-	1/4"	38	10	315	325		
57976	M12-M14	1/2"-9/16"	-		14			6	
57977	MF16-MF20	-	3/8"-1/2"	45	18	450	415		•
57978	M16-M20	5/8"-3/4"	-						
57979	MF21-MF26	-	5/8"-3/4"	55	22	560	500	4	
57980	M22-M24	7/8"-1"	-						
57981	MF27-MF36	-	7/8"-1"	65	18	630	600	2	
57966	M27-M36	1.1/8"-1.3/8"	-		25				
57967	M39-M42	1.1/2"-1.5/8"	-	75	30	800	725		
57968	M45-M52	1.3/4"-2"	-	90	36	900	800	1	
57969	M55-M62	-	1.3/4"-2"	105	22	1000	850		

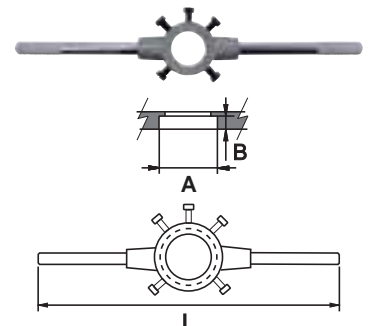





DIN 225 ISO 22568

ESPECIFICACIONES TÉCNICAS / TECHNICAL SPECIFICATION / DÉTAILS TECHNIQUES

Material / Material / Matière Acero + Zamak / Steel + Zamak / Acier + Zamak

■ **KITS DE ROSCADO / THREADING KITS / KIT DE FILETAGE / SCHNEIDSÄTZE / KIT DI FILIERE / CONJUNTOS DE ROSCAGEM / КОМПЛЕКТЫ ДЛЯ НАРЕЗАНИЯ РЕЗЬБЫ**

IN!

COD.		COD. PCS.		COD. PCS.		COD. PCS.		COD. PCS.	
57690		57701 57702 57703	-	-	-	-	-	-	800
57691	M3-M4-M5-M6-M8-M10-M12	57704 57706 57708 57710	M3-M4-M5-M6-M8-M10-M12	57846 57847 57848, 57849 57851 57853 57854	M3-M12+G	57837	25 x 9	57973	1600
57692	M6-M8-M10-M11-M12	57704 57706 57708 57709 57710	M6-M8-M10-M11-M12	57849 57851 57853 57856 57857	M4-M12+G	57838	25 x 9; 30 x 11; 38 x 14	57973 57974 57976	2000
57693	M6-M8-M10-M12-M14-M16-M18	57704 57706 57708 57710 57711 57712 57713	M6-M8-M10-M12-M14-M16-M18	57849 57851 57853 57857 57858 57859 57860	M3-M12 + G M5-M20 + G	57837 57839	25 x 9; 38 x 14; 45 x 18	57973 57976 57978	5600
57694	BSW 1/8", 3/16", 1/4", 5/16", 3/8", 7/16", 1/2"	57760 57762 57763 57764 57765 57766 57767	BSW 1/8", 3/16", 1/4", 5/16", 3/8", 7/16", 1/2"	57900 57902 57903 57904 57905 57906 57907	M3-M10 M4-M12 + G M2-M10 REV.	57836 57838 57830	30 x 11; 38 x 14	57974 57976	4400
57695	UNC 1/4", 5/16", 3/8", 7/16", 1/2", 5/8", 3/4"	57788 57789 57790 57791 57792 57794 57795	UNC 1/4", 5/16", 3/8", 7/16", 1/2", 5/8", 3/4"	57928 57929 57930 57931 57932 57934 57935	M3-M10 M4-M12 + G	57836 57838	20 x 7; 25 x 9; 30 x 11; 38 x 14; 45 x 18	57972 57973 57974 57976 57978	8000
57696	UNF 1/4", 5/16", 3/8", 7/16", 1/2", 5/8", 3/4"	57808 57809 57810 57811 57812 57814 57815	UNF 1/4", 5/16", 3/8", 7/16", 1/2", 5/8", 3/4"	57948 57949 57950 57951 57952 57954 57955	M3-M10 M5-M20 + G	57836 57839	20 x 7; 25 x 9; 30 x 11; 38 x 10; 45 x 14	57972 57973 57974 57975 57977	8000
57697	GAS (BSP) 1/8", 1/4", 3/8", 1/2", 3/4", 1"	57820 57821 57822 57823 57824 57825	GAS (BSP) 1/8", 1/4", 3/8", 1/2", 3/4", 1"	57960 57961 57962 57963 57964 57965	M4-M12 + G M5-M20 + G M13-M32 + G	57838 57839 57841	30 x 11; 38 x 10; 45 x 14; 55 x 16; 65 x 18	57974 57975 57977 57979 57981	14500

